

BURNDY Grounding Kits

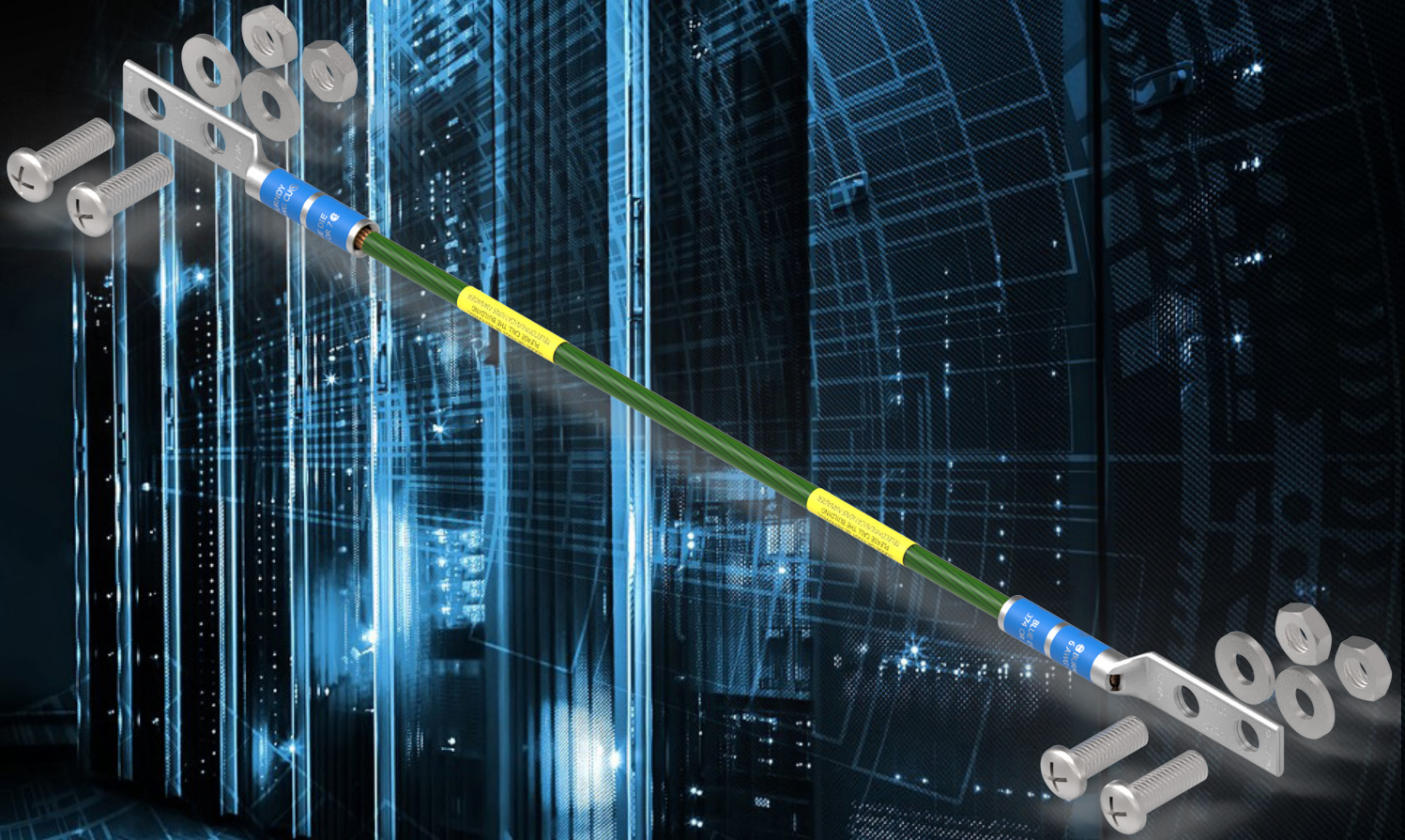

Connecting Power to Your World®

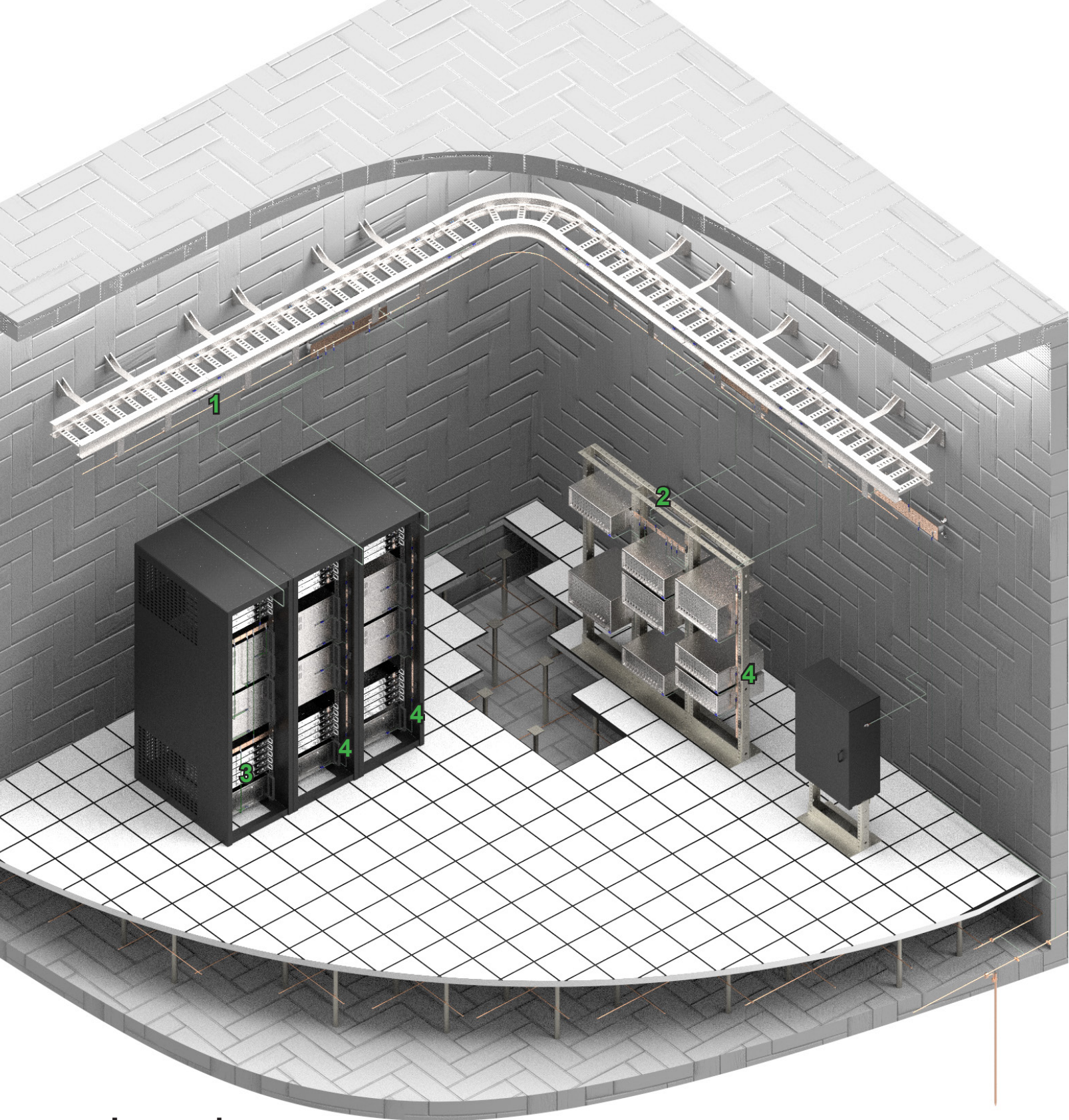



Legend:

- 1** Ladder Tray Kit (BGRKTD9D)
- 2** On-Rail Busbar Grounding Kit (BGRKTHC)
- 3** Ground Conductor Jumper Kit (BGRKTD30DN)
- 4** In-Cabinet Busbar Grounding Kit (BGRKTVK)

On-Rail Busbar Grounding Kit

Catalog Number: BGRKTHC

- 19" Busbar used to consolidate equipment grounds
- Isolators included to separate bar from rack if necessary



Includes:

- 3/4"x19" busbar
- busbar hardware kit
- 60" #6 AWG conductor
- YAZ6C2TC14 HYDENT™ terminal (pre-crimped to conductor on one side)
- 8" Black Hook & Loop Cable Fastener (10 pieces)
- ESD Port Kit
- ESD Identification Label
- Additional Labeling
- 1/2 ounce PENETROX™ A oxide inhibitor
- Installation hardware necessary
- Installation instructions

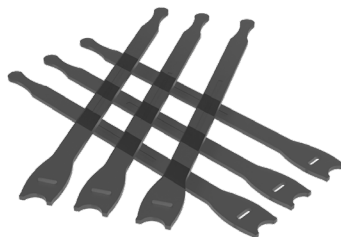

In-Cabinet Busbar Grounding Kit

Catalog Number: BGRKTVC

- 36" Vertical busbar used to ground equipment on the rack
- Studded end can be used to splice bars together
- Isolators included to separate bar from rack if necessary

Includes:

- 36" busbar
- busbar hardware kit
- 60" #6 AWG conductor
- YAZ6C2TC14 HYDENT™ terminal (pre-crimped to conductor on one side)
- 8" Black Hook & Loop Cable Fastener (10 pieces)
- ESD Port Kit
- ESD Identification Label
- Additional Labeling
- 1/2 ounce PENETROX™ A oxide inhibitor
- Installation hardware necessary
- Installation instructions

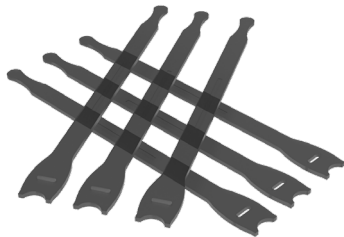
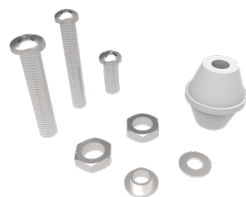

Ladder Tray Kits

Catalog Number: BGRKTD9D

- Used to bond sections of ladder tray
- Other sizes available upon request

Includes:

- 9" #6 AWG Conductor
- YAZ6C2TC14 HYDENT™ terminals pre-crimped to each end of conductor
- 1/2 ounce PENETROX™ A oxide inhibitor
- Hardware Kit
- Labels for conductor
- Ground Symbol Label
- Installation instructions

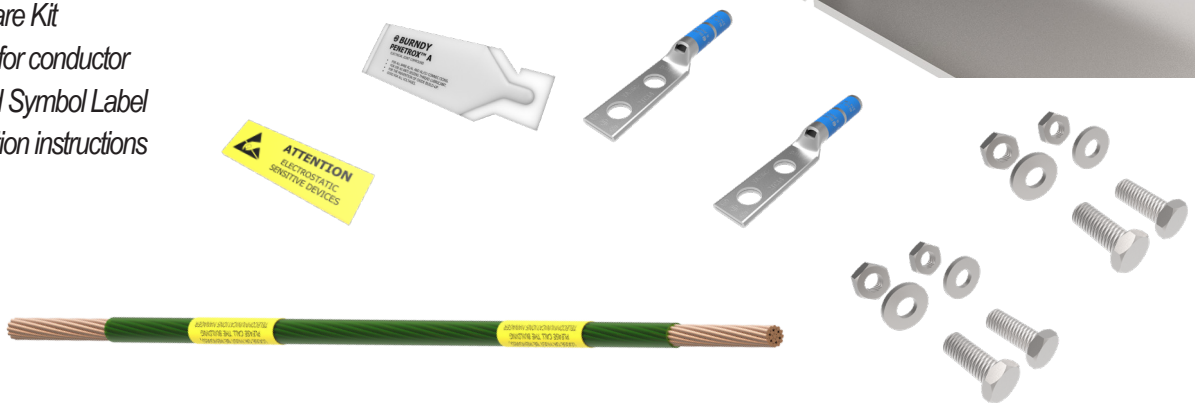
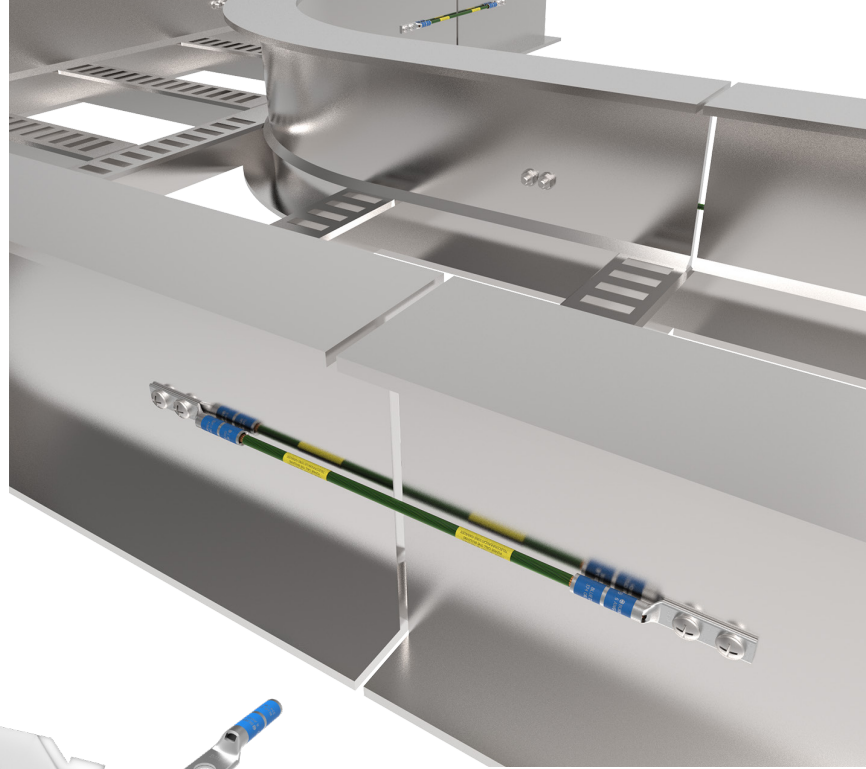

Wire Basket Tray Bonding Jumper Kit

Catalog Number: BGRKTWB5

- Used to bond sections of wire basket
- Sold in packages of 5
- Other sizes available upon request

Includes:

- 9" #6 AWG Conductor (5 pieces)
- KS23 SERVIT® split bolt connectors (10 pieces)
- Ground wire labeling (5 pieces)
- Ground symbol labeling (5 pieces)
- Installation instructions

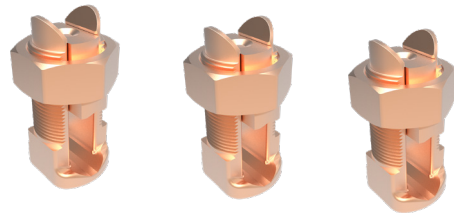

Ground Conductor/Jumper Kits

Ground Conductor / Jumper Kits

- Used to bond equipment
- Other sizes available upon request

Catalog Number: BGRKTKA9KA5

Includes:

- 9" #6 AWG Conductor (5 pieces)
- KA6U mechanical terminal (10 pieces)
- 1/2 ounce PENETROX™ A oxide inhibitor
- Installation hardware necessary
- Ground wire labeling (5 pieces)
- Installation instructions

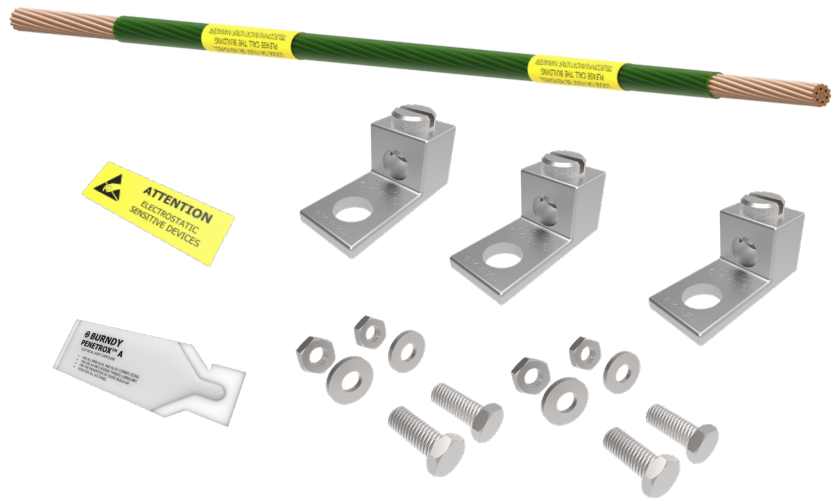

Catalog Number: BGRKTDB60C46

Includes:

- 60" #6 AWG Conductor
- YAZ6C2TC38 HYDENT™ terminal pre-crimped to one end of conductor
- YC4C6 Copper CRIMPIT™ pre-crimped to the other end of conductor
- 1/2 ounce PENETROX™ A oxide inhibitor
- Hardware Kit
- Labeling
- Installation instructions

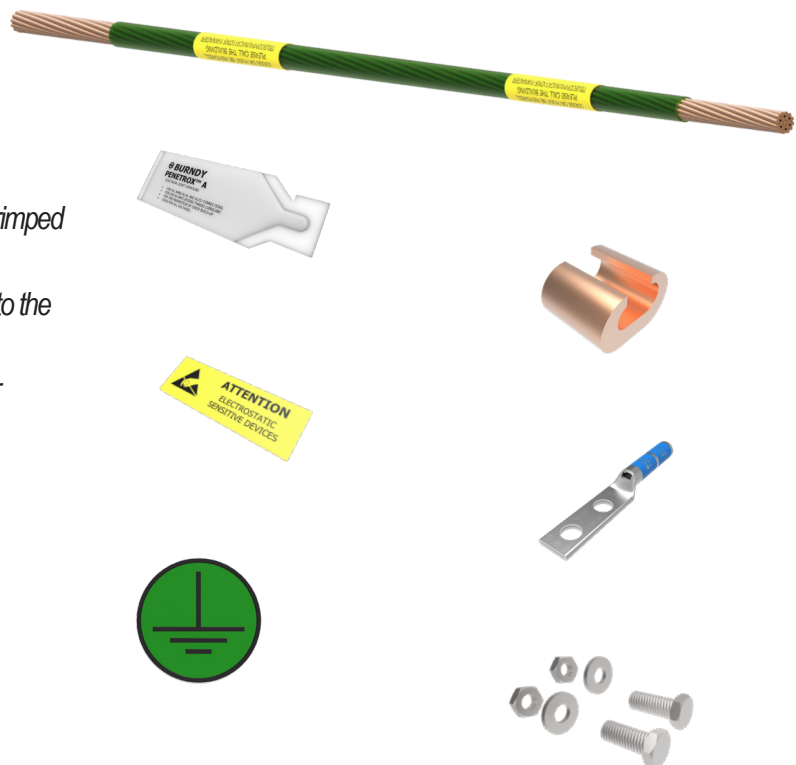

Ground Conductor/Jumper Kits *(continued)*

Catalog Number: BGRKTD30DN

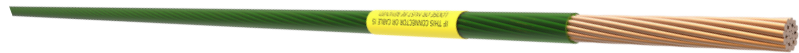

Includes:

- 30" #6 AWG Conductor
- YAZ6C2TC14 HYDENT™ terminal pre-crimped to one end of conductor
- YAZ6C2TC1490 HYDENT™ terminal pre-crimped to the other end of conductor
- 1/2 ounce PENETROX™ A oxide inhibitor
- Hardware Kit
- Labeling
- Installation instructions

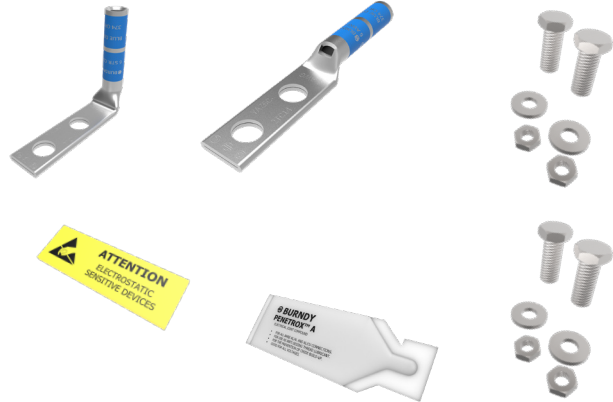

FOCUS
SPECIALIZED SOLUTIONS

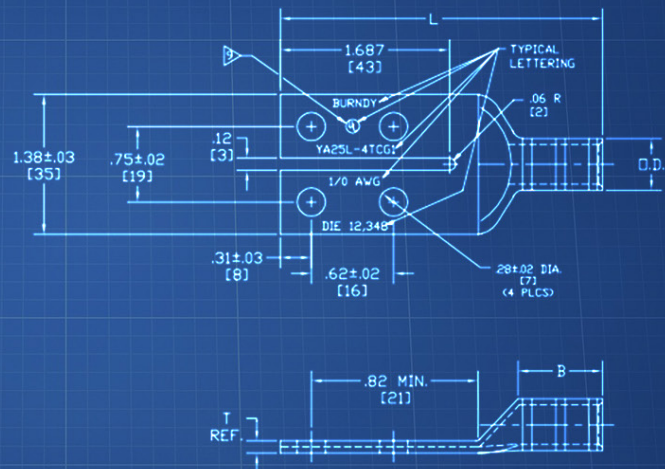

Have a specific application that the standard grounding kits do not cover?
Stud size slightly off, want a different connector, hole spacing or bus bar?

BURNDY is the solution to this type of dilemma. Our FOCUS process streamlines the design process for all your variation requirements. Contact your local BURNDY sales representative for more information.



Customer Service Department

7 Aviation Park Drive

Londonderry, NH 03053

1-800-346-4175

1-800-451-4956 (Technical Services)

1-800-647-5299 (International)

Canada

1-800-361-6975 (Quebec)

1-800-387-6487 (All other provinces)

Mexico

011-52-722-265-4400

Brazil

011-55-11-5515-7225

Tool Service Center

Littleton Industrial Park

Littleton, NH 03561

1-800-426-8720



© BURNDY LLC, 2019

Connecting Power to Your World®

